

D-1	1033	395	16	x 1	1/1
D-2	1033	395	16	x 1	1/1
D-3	632	394	16	x 1	1/1
D-4	632	394	16	x 1	1/1
D-5	632	372	16	x 1	1/1
D-6	482	300	16	x 1	1/1
D-7	502	345	16	x 1	1/1
D-8	632	90	16	x 1	1/1
D-9	628	24	16	x 1	1/1
D-10	426	626	16	x 1	1/1
D-11	496	416	16	x 1	1/1
D-12	496	206	16	x 1	1/1
D-13	300	120	16	x 1	1/1
D-14	300	120	16	x 1	1/1
D-15	446	120	16	x 1	1/1
D-16	476	306	3	x 1	1/1
D-17	1014	646	3	x 1	1/1

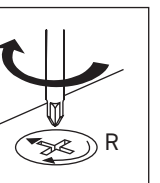

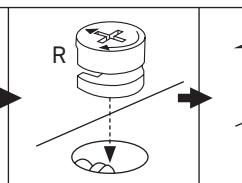

1

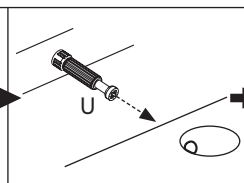
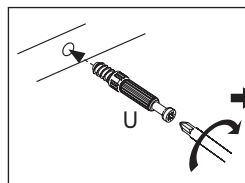
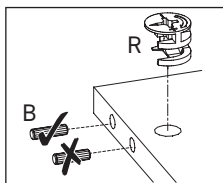
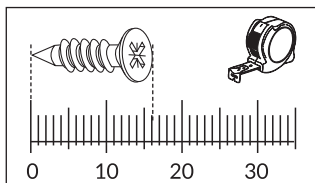
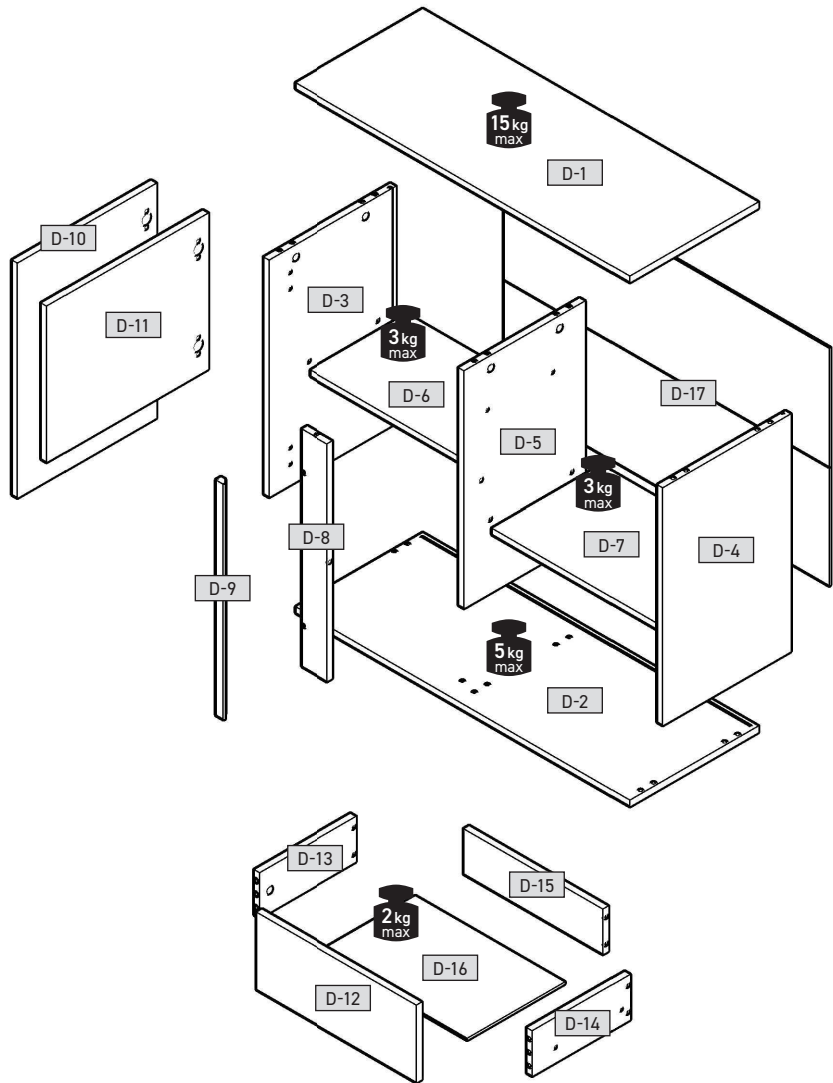

B x12 8x32mm	C3+D x4 W	K6 x1 L=300mm	T3 x4 5x9mm	U x6 L=24,3mm
------------------------	---------------------	-------------------------	-----------------------	-------------------------

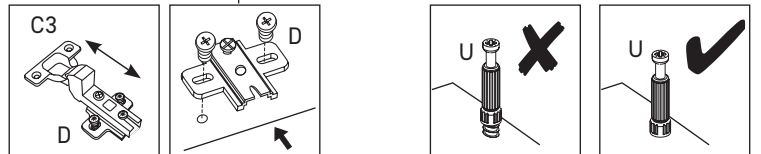
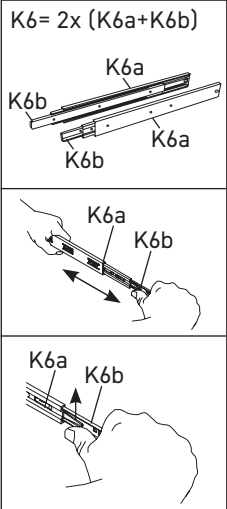
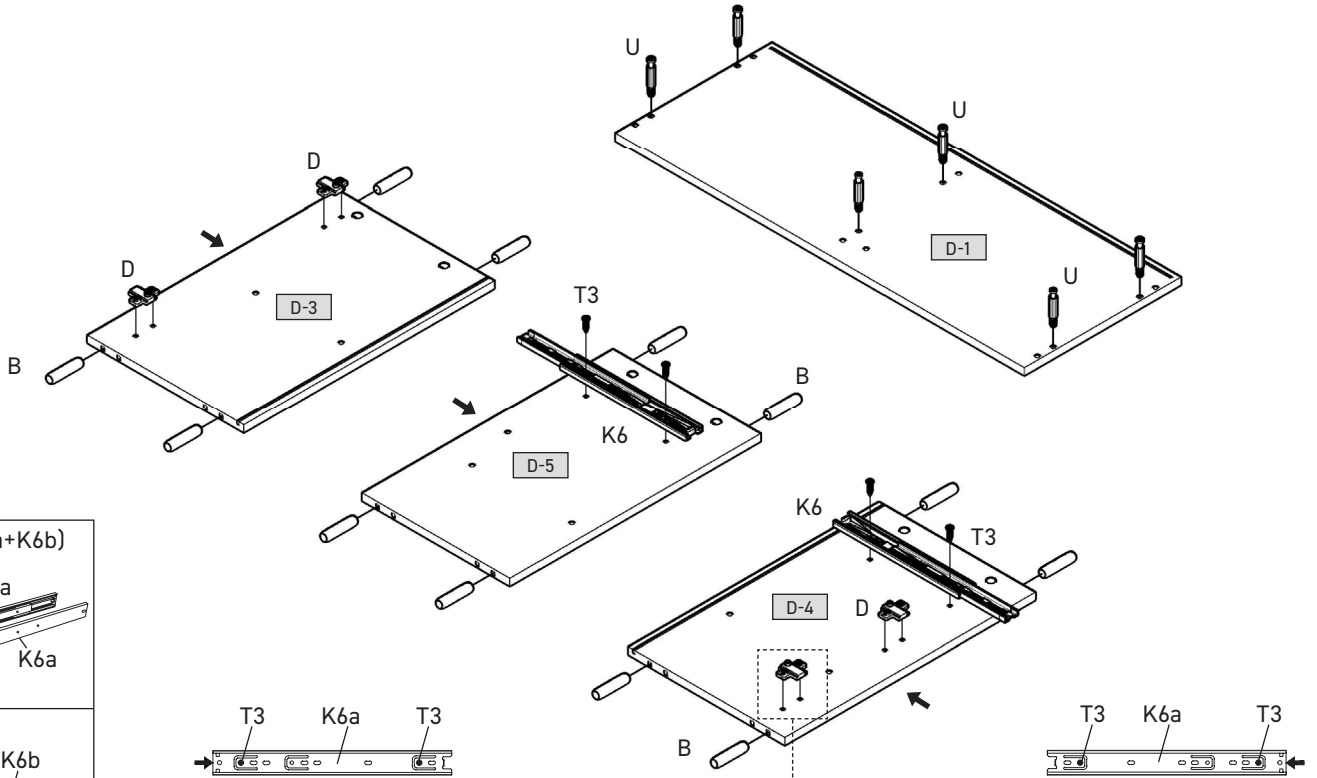

2

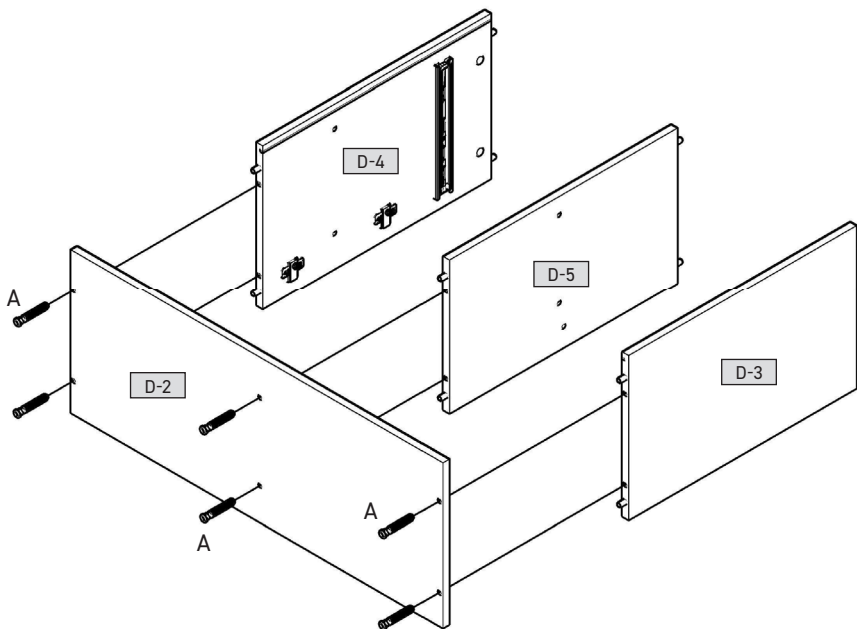

A x6 7x50mm
XA x1

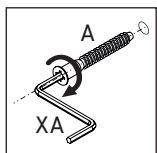



3

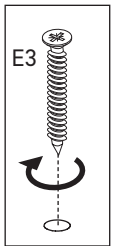
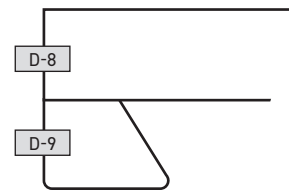
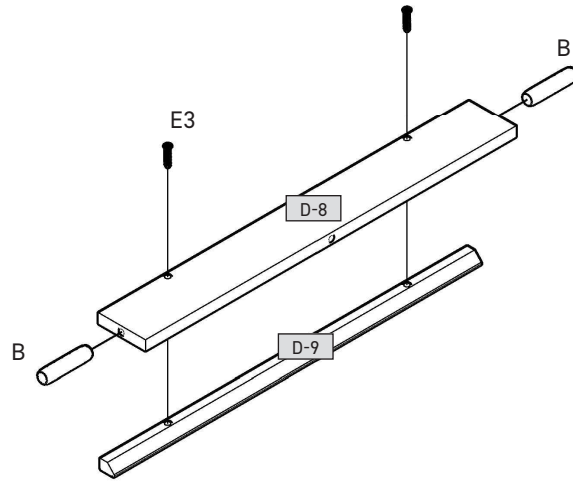
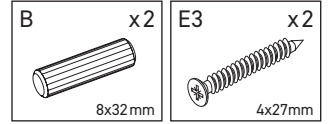

4

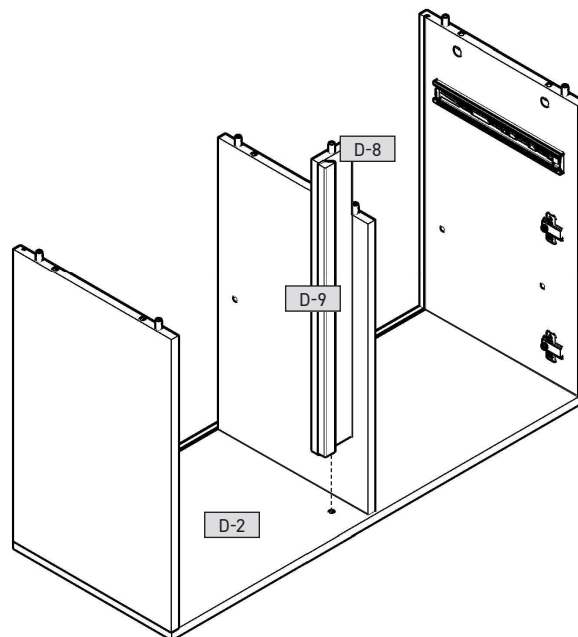



5

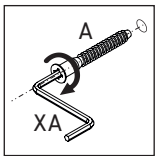
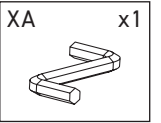
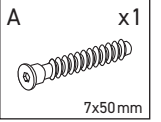
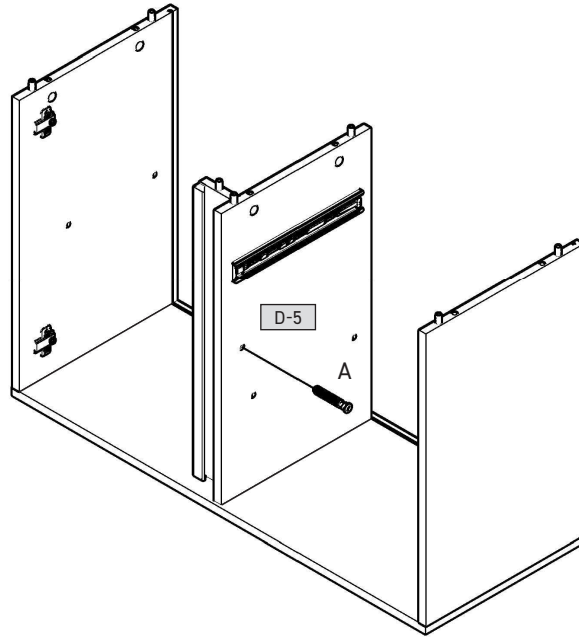

6

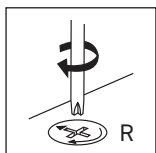
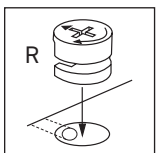
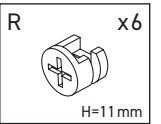
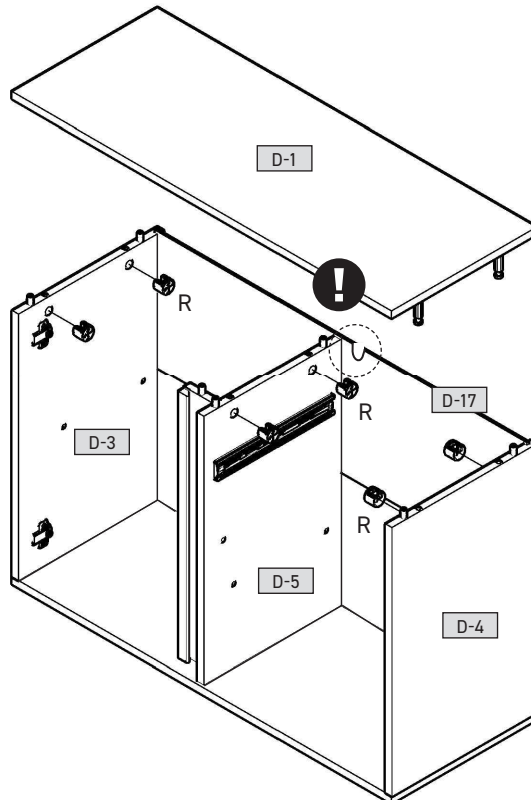



7

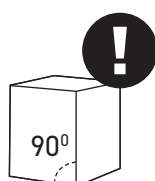
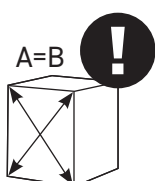
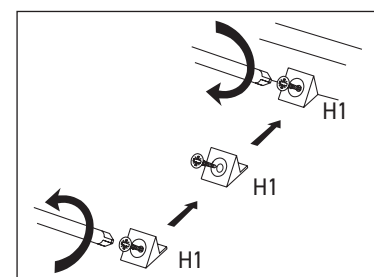
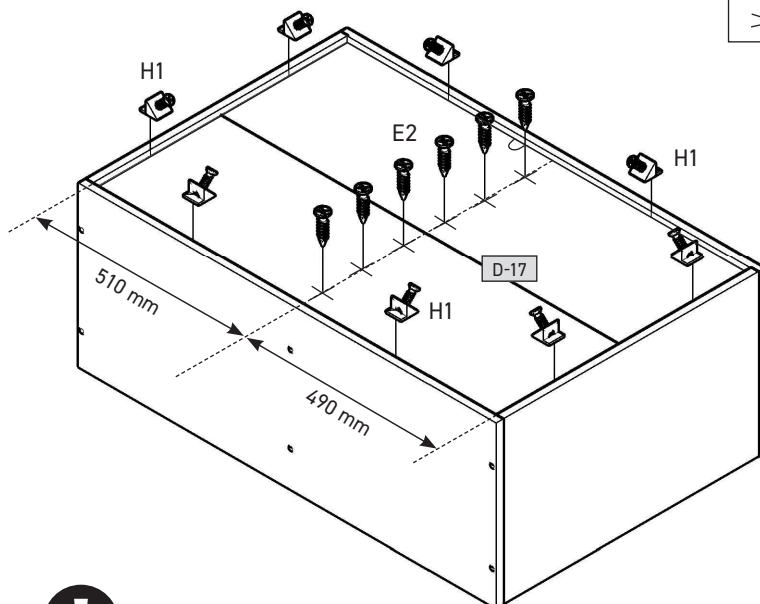
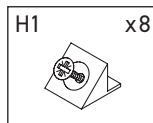
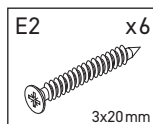
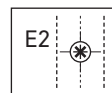
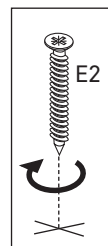

8

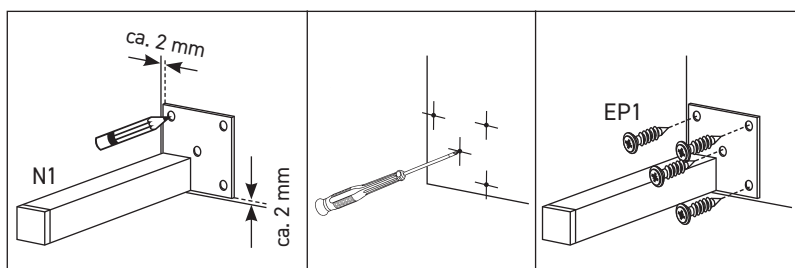
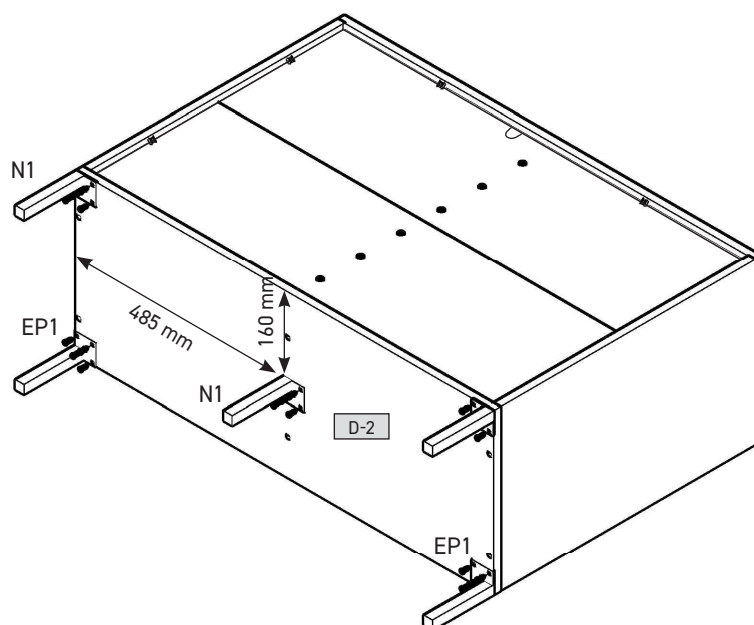
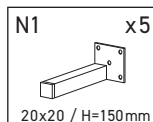
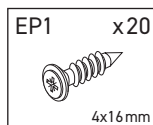



9

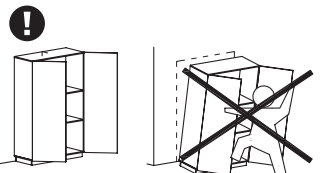
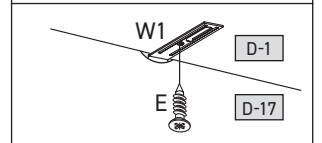
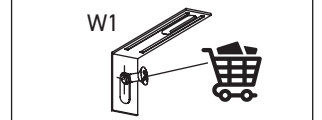
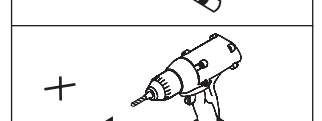
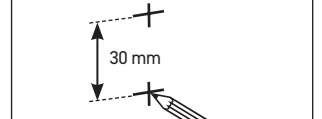
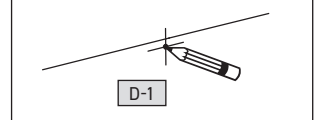
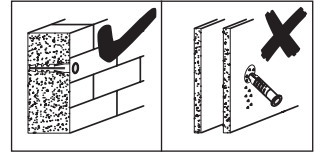
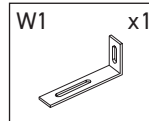
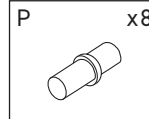
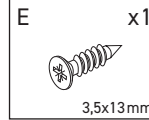
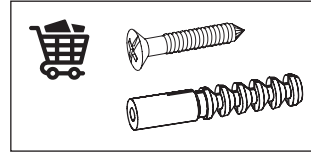
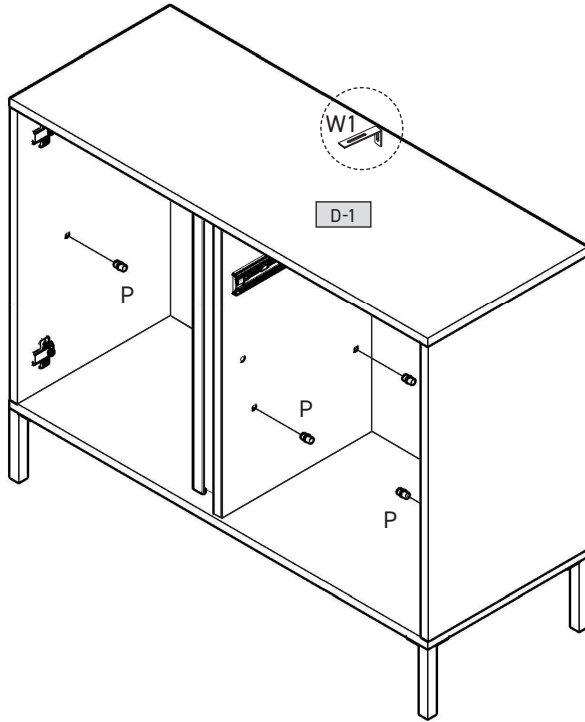
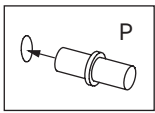
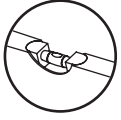

10

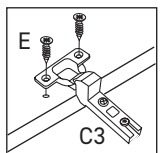
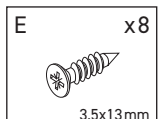
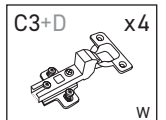
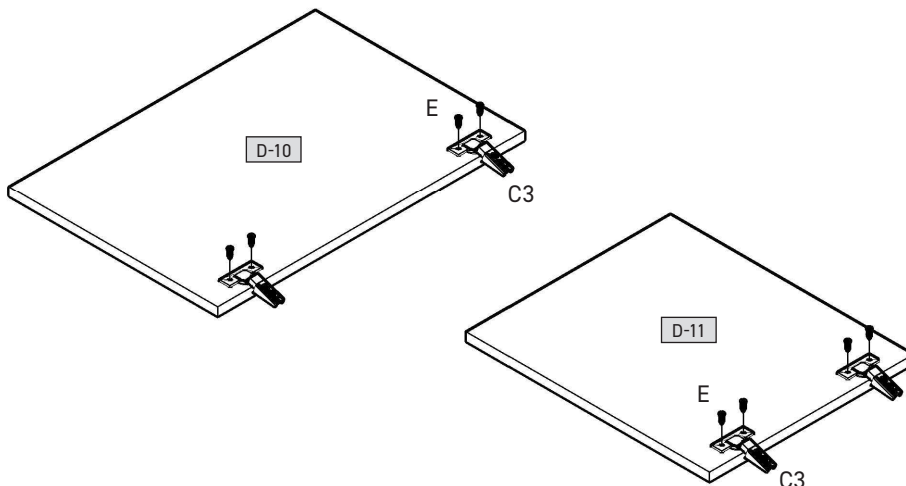



11

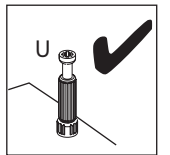
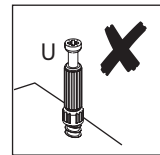
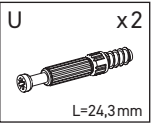
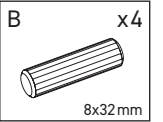
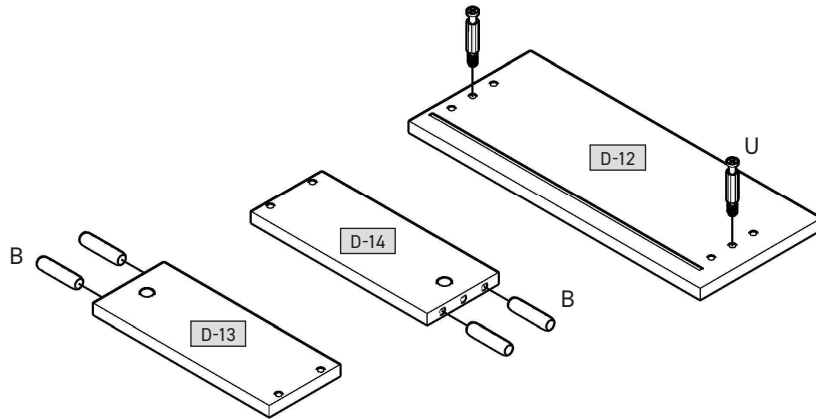

12

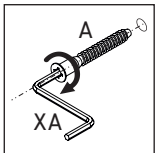
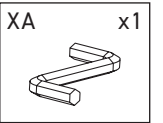
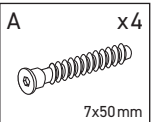
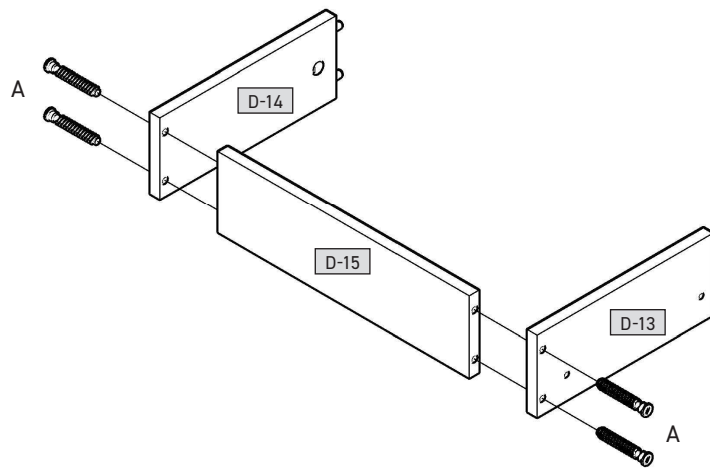

13

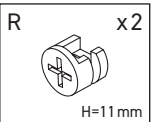
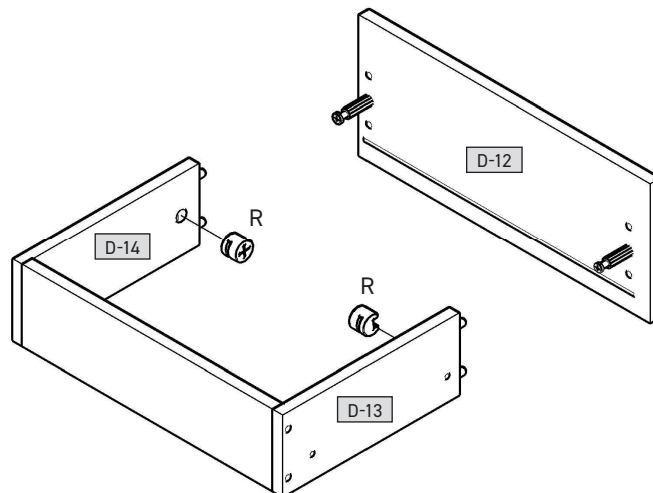
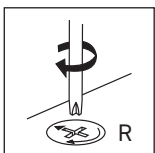
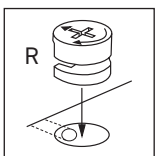



14

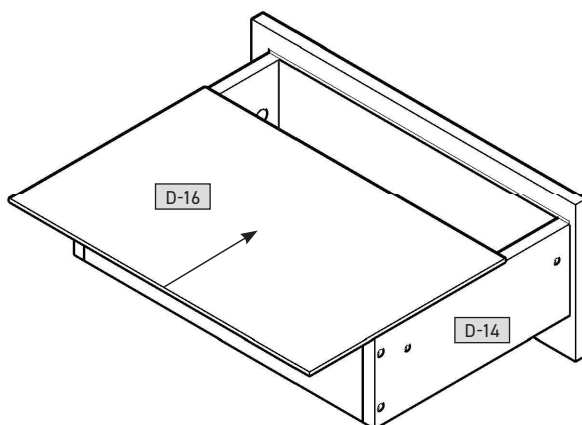

15

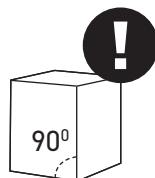
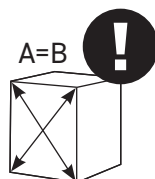
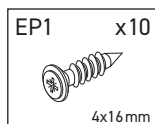
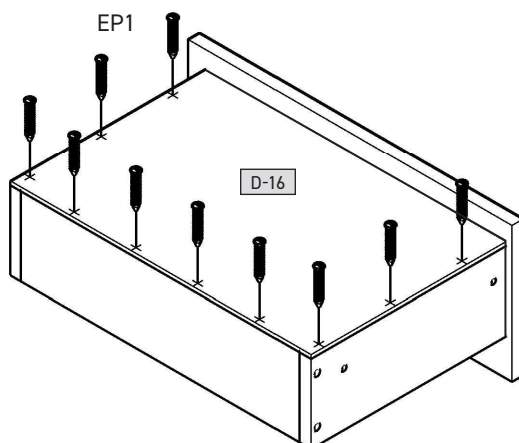
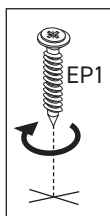

16

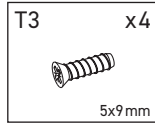
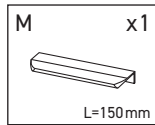
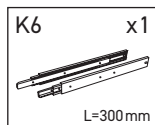
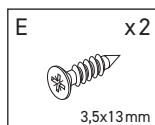
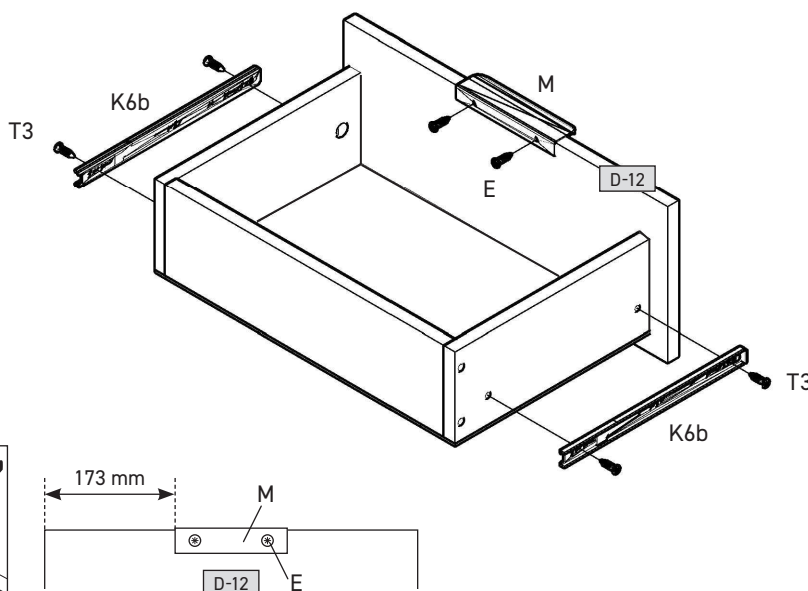
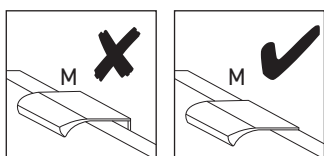
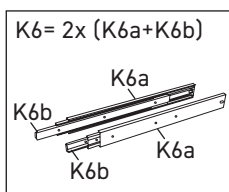



17

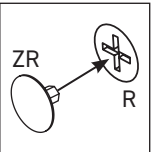
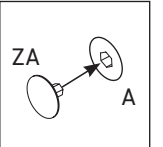
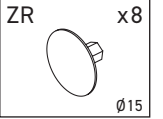
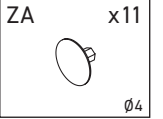
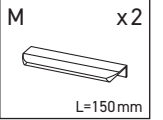
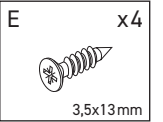
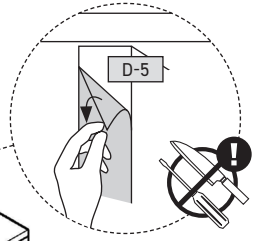
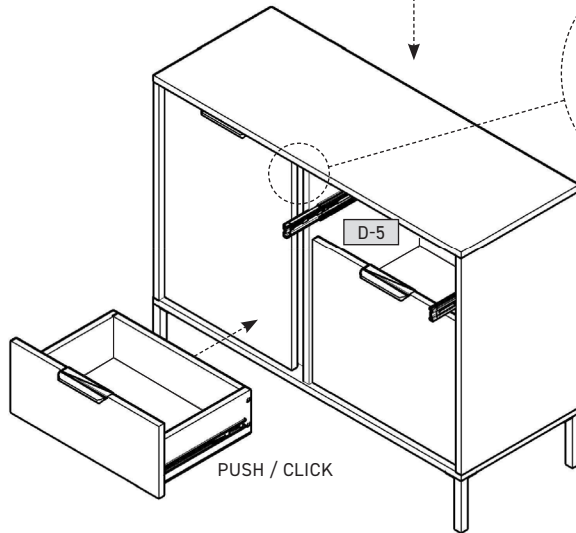
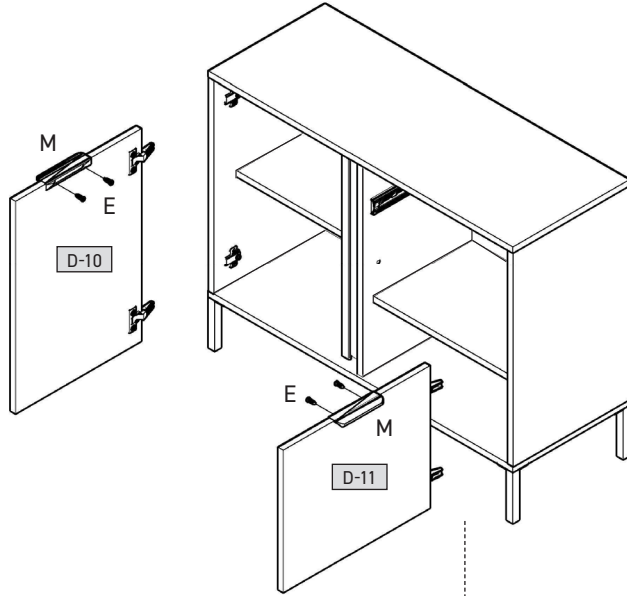
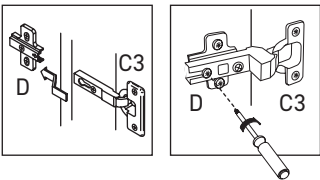
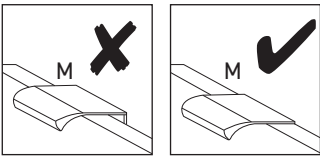
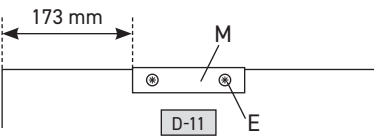
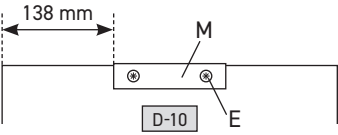

18

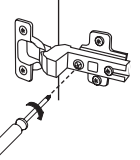
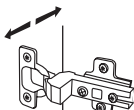
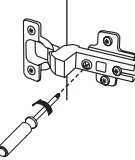
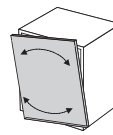
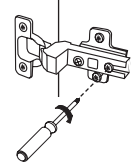
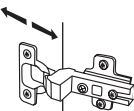
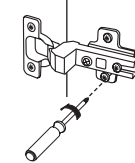
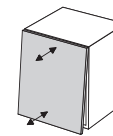
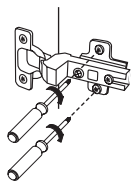
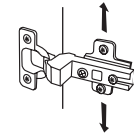
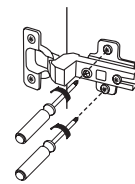
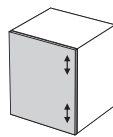
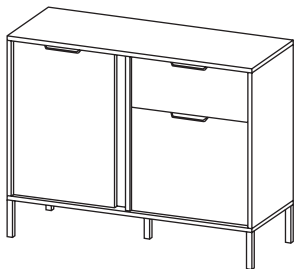

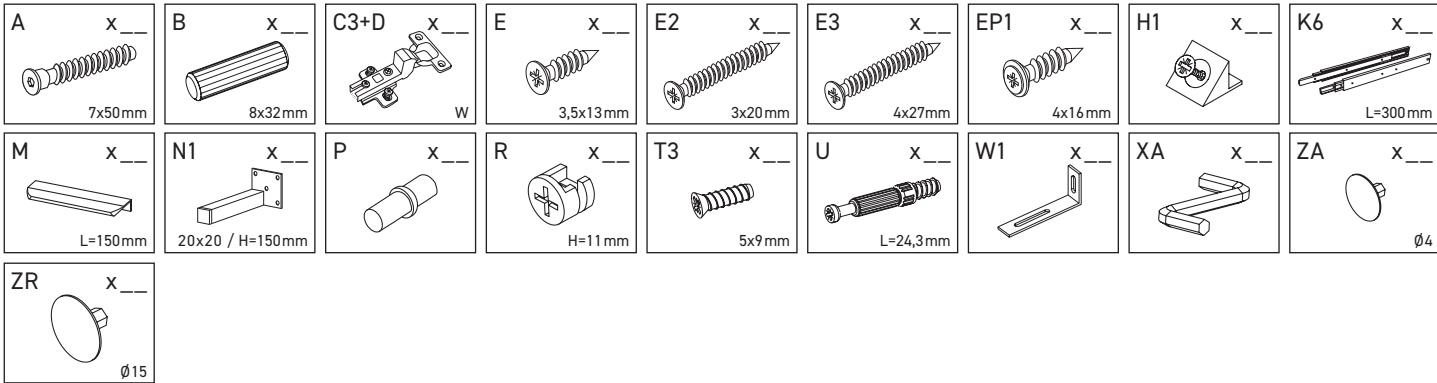

D-1	1033	395	16	x 1	1/1
D-2	1033	395	16	x 1	1/1
D-3	632	394	16	x 1	1/1
D-4	632	394	16	x 1	1/1
D-5	632	372	16	x 1	1/1
D-6	482	300	16	x 1	1/1
D-7	502	345	16	x 1	1/1
D-8	632	90	16	x 1	1/1
D-9	628	24	16	x 1	1/1
D-10	426	626	16	x 1	1/1
D-11	496	416	16	x 1	1/1
D-12	496	206	16	x 1	1/1
D-13	300	120	16	x 1	1/1
D-14	300	120	16	x 1	1/1
D-15	446	120	16	x 1	1/1
D-16	476	306	3	x 1	1/1
D-17	1014	646	3	x 1	1/1

